



PROJECT		REF		REV	ITEM CODE	
LOCATION		DATE			Page	

## SANITARY WARE SPECIFICATION SHEET

Item Descriptions	Stern (Israel) "Smart SD" Chrome plated liquid soap dispenser with built-in sensor in DC Supply with 6DD battery box	Illustration/ Drawing 
Model	Smart Soap Dispenser B	
Code Number	235920	
Finish	Chrome Plated	
Supplier	Acme Sanitary Ware Co. Ltd Mr. Eric Wong/ Mr. Don Yuen	
Contact Tel/Fax	(852) 2388-7171 / (852) 2710-8012	
E-mail	acme@acmesanitary.com.hk	
Website	www.acmesanitary.com.hk	

**SMART SOAP DISPENSER B**  
**Ref # 235920**

Touch free electronic soap dispenser for deck mounted installations. Activated by infrared sensor. Chrome plated body, other finishes available. Includes a 1 liter soap bottle and bottle support. Optional for remote installation: extension cable and longer piping. The following functions can be performed by using Stern remote control: soap quantity selection, refill the soap tank, temporary off, coming back to factory settings.

\*Versions for multifeed installation available.

**Application:**  
 Closing automatically without dripping, Stern's touch free soap dispenser helps to ensure that the bathroom will stay organized and neat. Combined with Smart touch free electronic faucet, it creates a germ-free and automated environment.

**Use:**  
 Touch free electronic soap dispenser. The soap dispenser is activated automatically when the users bring their hands within the sensor range and stops when the users remove their hands.

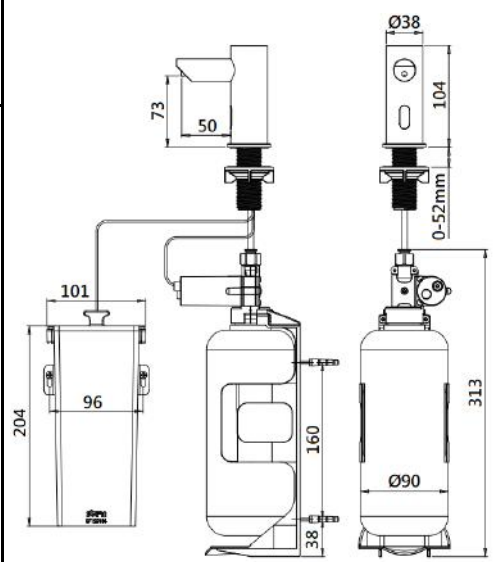







**PRODUCT AT A GLANCE**

Installation	Deck-mounted
Power Supply	<ul style="list-style-type: none"> <li>9V battery</li> <li>12V transformer</li> </ul>
Soap	1 Liter soap bottle. Peristaltic pump enables the use of any kind of liquid soap, detergent or antibacterial gel
Soap Dose	Default setting: 1.2-1.6 cc Adjustable by remote control in accordance to the selected soap.
Refill	Soap priming operated by remote control or by easy-to-use manual refill button

**ORDERING INFORMATION**

MODEL	CODE	POWER
SMART SOAP DISPENSER B	235920	9V BATTERY
SMART SOAP DISPENSER E	235900	12V TRANSFORMER

-  **Installation:**  
Lavatory mounted
-  **Power source:**  
Battery box for 6xDD batteries
-  **Stern Soap & Water:**  
Smart matching faucet
-  **Default soap dosage:**  
1.4 cc
-  **Soap viscosity:**  
100-3800 cPs
-  **Accessories:**  
Soap dispenser remote control

\* All information of the above is for the reference only. No prior notice is made if any changes.



PROJECT		REF		REV	ITEM CODE	
LOCATION		DATE			Page	

## SANITARY WARE SPECIFICATION SHEET

Smart Soap Dispenser B  
(235920)

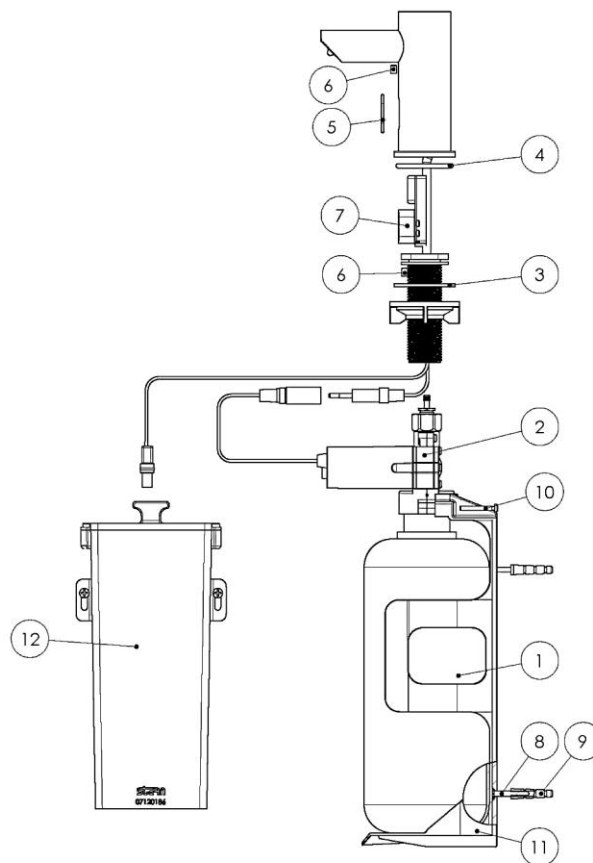

Quantity	Part Number	Description	Cat. No.
-	-	<b>Seals and Screws Kit</b>	<b>07210088</b>
1	4	O-ring	
1	5	O-ring	
2	6	Screw	
1	3	Gasket	
2	8	Screw	
2	9	Anchor	
2	10	Screw	
-	-	<b>Sensor Kit</b>	<b>07220072</b>
1	7	Electronic Unit	
1	5	O-ring	
	<b>1</b>	<b>Soap Tank 1L</b>	<b>07100020</b>
	<b>2</b>	<b>Pump Soap Dispenser</b>	<b>07222001</b>
	<b>11</b>	<b>Bottle 1L support</b>	<b>07120175</b>
	<b>12</b>	<b>Battery box</b>	<b>06530041</b>

\* All information of the above is for the reference only. No prior notice is made if any changes.



## INSTALLATION

### STEP 1 – REMOVE ALL MOUNTING HARDWARE

**For TRENDY, ELITE, EXTREME, SMART, GREEN, GREEN 28 Soap Dispensers:**

Drill a hole in the deck or lavatory according to the recommended hole size.

Remove the nut, the disk and the gasket from the base of the soap dispenser body.

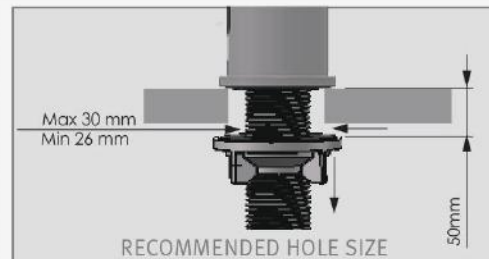

If your dispenser is supplied with anti-rotation solution, drill an additional hole for anti-rotation pin.

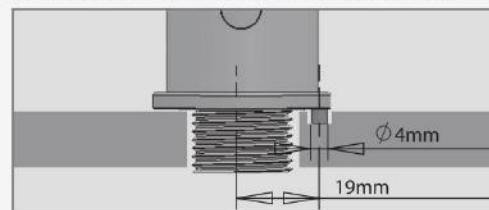

**For CSABA Soap Dispenser:**

Remove the hexagonal nut, disk and washer. Do not remove the O-ring from the base of the faucet.

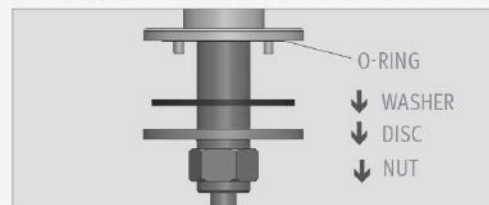

Drill a hole in the counter for the mixing handle. Remove the nut, disk and seal.



### STEP 2 – INSTALLING THE SOAP DISPENSER

1

**For TRENDY, ELITE, EXTREME, SMART, GREEN, GREEN 28 Soap Dispensers:** Place the soap dispenser body along with the bottom ring into the hole in the deck or lavatory.

Slide the gasket, disk and nut over the soap dispenser body nipple and secure it.

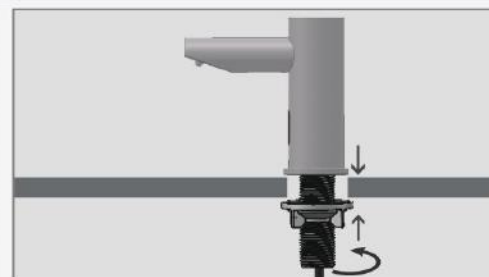

**For CSABA Soap Dispenser:**

Slide the washer, disk and hexagonal nut over the flexible hose and secure the faucet into place.

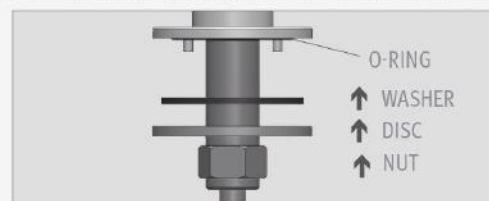



## INSTALLATION

2

Fix the bottle with bottle support to the desired location.

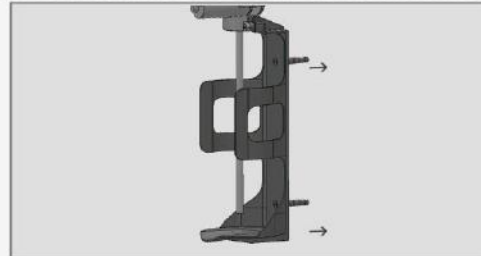

3

Snap the soap pipe from the dispenser body into the quick connection fitting of the pump.

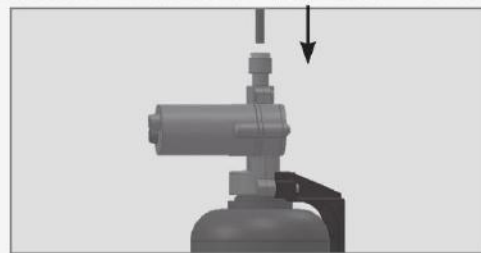

### STEP 3 – CONNECTING THE POWER SOURCE

1

Remove the protective sticker covering the sensor. Keep away from the sensor range.

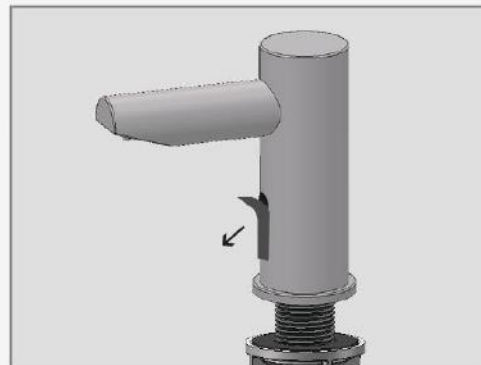

2

Connect the motor connector to its matching connector coming from the electronic unit. Please note that since the connector is water proof, some friction might apply.





## INSTALLATION

**IMPORTANT:** the 4 contacts connector should be connected properly so that the white o-ring is not visible and a clicking sound is heard.

**PAY ATTENTION:** If the 4 contacts connectors is not connected properly, the motor will work continuously.

2a

**For battery versions:** install the battery box on the wall underneath the sink and connect the battery connector.

**Caution:** make sure to connect the connectors according to the indication on the battery box sticker.



2b

**For transformer versions:** plug the transformer into the electricity socket and connect the transformer connector









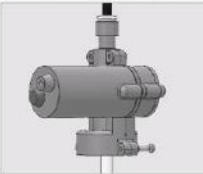

3

Wait about 10 seconds before you put your hands within the sensor range.

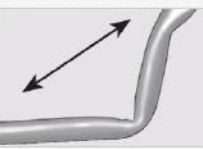

## TROUBLESHOOTING

Indication	Investigation	Cause	Solution	Illustration
False activation: Soap dispensing	Continuous discharge from the nozzle	AUX connector not fully inserted	The connector should be inserted fully until white o-ring is not visible. Remove the o-ring if necessary	
	Random discharge from the nozzle	Reflection issue from other object	Eliminate any cause of reflection and if necessary use appropriate remote control to shorten detection range.	
	Soap discharging from pump housing.	Damaged pump due to high viscosity or debris in pipes	Replace the Pump. Rinse warm water through the pipe and the body of the soap dispenser all the way to the nozzle.	
Soap not dispensing	Pump is making sounds when sensor is activated	Soap tank is empty	Fill with soap with correct viscosity (100 - 3800 cPs) and prime pipes using the fill button on remote control.	
		Soap dispenser has not been primed	Prime the soap dispenser by pressing the fill button on the remote or by pressing the refill button located at the bottom of the pump, until soap exits the nozzle.	
		Damaged pump (discharge from housing)	Replace the Pump	
		Debris or dried soap in the pipe or tank	Run warm water through pipe, pump, and body all the way to the nozzle. Replace with soap of correct viscosity.	
		High viscosity soap (> 3800 cPs)	NOTE: Using the soap dispenser with high viscosity soap may cause permanent damage to the pump and shorten the lifecycle.	
		Bent pipes	Unbend or straighten pipes.	



## TROUBLESHOOTING

Indication	Investigation		Cause	Solution	Illustration	
Soap not dispensing	Pump is not making sound when the sensor is activated	Sensor is blinking when hand is placed in front	AUX connector not fully inserted	The connector should be inserted fully until the white o-ring is not visible. Remove the o-ring if necessary		
			Refill button on pump does not activate the pump.	Replace the Pump. Rinse warm water through the pipe and the body of the soap dispenser all the way to the nozzle.		
			Damaged pump (discharge from housing).			
			Debris or dried soap in the tank or tubing	Run warm water through pipe, pump, and body all the way to the nozzle. Replace with soap of correct viscosity. NOTE: Using the soap dispenser with high viscosity soap may cause permanent damage to the pump and shorten the lifecycle.		
	Sensor is not blinking when hand is placed in front	Refill button on pump does not activate the pump.	Transformer: Check operation with functioning transformer. Where necessary replace with appropriate transformer. For part numbers see spare parts list.	Battery: Check operation with functioning battery pack. Where necessary, replace batteries or replace the battery pack: Battery pack (without batteries)		
					Reflection issue from other object	Eliminate any cause of reflection and use appropriate remote control to shorten detection range.
		Damaged sensor	If the above two solutions have not resolved this issue replace with appropriate sensor. For part numbers see spare parts list.			